

Spannhub von max. 3,8mm

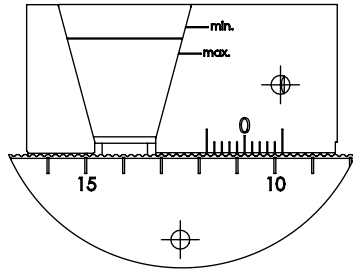

DETAIL A
MAßSTAB 1 : 2

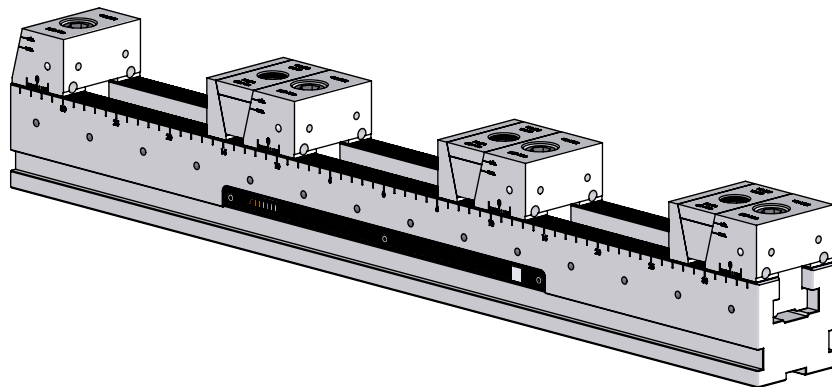
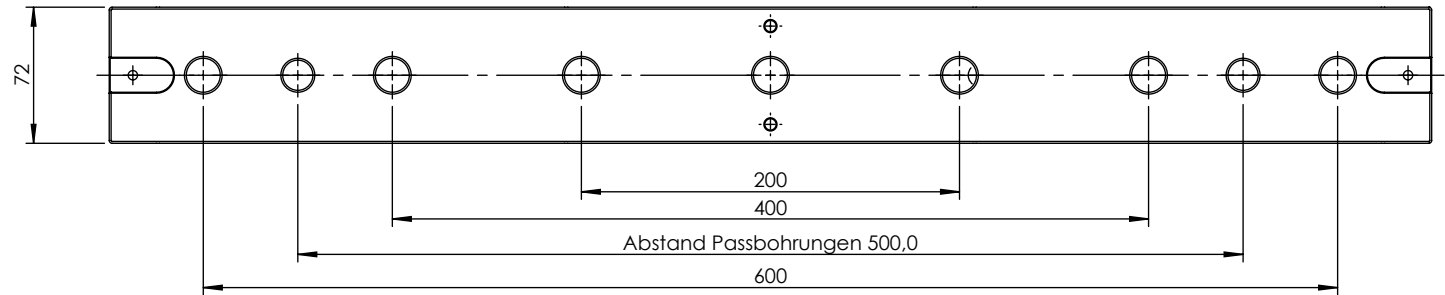

CombiRail b72 - 700
692 133 8000 755

Spannkraft: 38kN bei 60Nm
Stand 18.08.2023
Änderung vorbehalten